

# Ultra Vacuum Fittings

---

The best partner for value creation  
We support the innovations of customers



# 10



Catalogue No. S-LOK Mar.2024

## Features

- Sealing performance is maintained with repeated separation operation.
- All Stainless Steel 316 and FKM O-Ring
- Temperature Rating : -31 to 204°C (-25 to 400°F)
- The helium leak tested to a maximum leak rate of  $4 \times 10^{-9}$  atm. cc/s at ambient temperature.

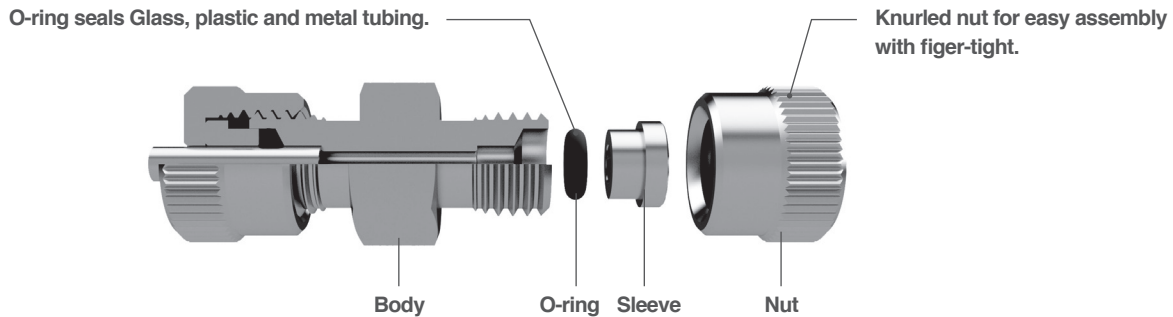

## Ordering Information and Dimensions

- Dimensions are for reference only and are subject to change.
- The E dimension refers to the smallest nominal inside diameter of the part.

UTMC	8	8N	S6
<b>Fitting Series</b>	<b>Ultra Vacuum Fitting Size</b>	<b>Connection Size</b>	<b>Body Material</b>
<ul style="list-style-type: none"> <li>• <b>UTU</b> : Union</li> <li>• <b>UTL</b> : Union Elbow</li> <li>• <b>UTT</b> : Union Tee</li> <li>• <b>UTUR</b> : Reducing Union</li> <li>• <b>UTMC</b> : Male Connector</li> <li>• <b>UTA</b> : S-LOK Tube Adapter</li> <li>• <b>UTUS</b> : S-LOK Fitting Connector</li> <li>• <b>UTN</b> : Nut</li> </ul>	<ul style="list-style-type: none"> <li>• 1 : 1/16"</li> <li>• 2 : 1/8"</li> <li>• 4 : 1/4"</li> <li>• 6 : 3/8"</li> <li>• 8 : 1/2"</li> <li>• 10 : 5/8"</li> <li>• 12 : 3/4"</li> <li>• 16 : 1"</li> <li>• 24 : 1-1/2"</li> </ul>	<ul style="list-style-type: none"> <li>• 4 : 1/4"</li> <li>• 6 : 3/8"</li> <li>• 8 : 1/2"</li> <li>• 10 : 5/8"</li> <li>• 12 : 3/4"</li> <li>• 16 : 1"</li> <li>• 20 : 1-1/4"</li> <li>• 24 : 1-1/2"</li> <li>• 2N : 1/8" NPT</li> <li>• 4N : 1/4" NPT</li> <li>• 6N : 3/8" NPT</li> <li>• 8N : 1/2" NPT</li> <li>• 12N : 3/4" NPT</li> <li>• 16N : 1" NPT</li> </ul>	<ul style="list-style-type: none"> <li>• <b>S6</b> : 316 Stainless Steel</li> </ul>

### Union UTU

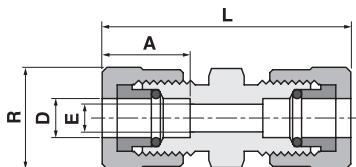

Part No.	Tube O.D		Dimensions mm			
	in.	mm	E	R	A	L
UTU-1	1/16	1.59	1.3	12.0	10.7	31.2
UTU-2	1/8	3.17	2.3	14.0	12.2	38.0
UTU-4	1/4	6.35	4.6	17.5	14.9	41.9
UTU-6	3/8	9.52	7.1	20.0	17.8	46.5
UTU-8	1/2	12.70	10.2	23.5	20.5	47.0
UTU-10	5/8	15.87	12.7	27.5	22.6	49.3
UTU-12	3/4	19.05	15.7	31.5	25.3	55.1
UTU-16	1	25.40	22.1	39.5	27.6	57.7
UTU-24	1-1/2	38.10	35.1	52.0	27.6	60.7

## Union Elbow

## UTL

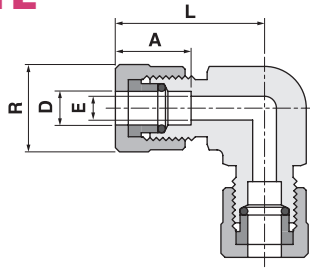

Part No.	Tube O.D		Dimensions mm			
	D		E	R	A	L
	in.	mm				
UTL-4	1/4	6.35	4.6	17.5	14.9	29.2
UTL-6	3/8	9.52	7.1	20.0	17.8	34.8
UTL-8	1/2	12.70	10.2	23.5	20.5	34.8

## Union Tee

## UTT

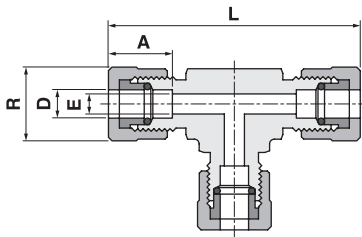

Part No.	Tube O.D		Dimensions mm				
	D		E	R	A	I	L
	in.	mm					
UTT-2	1/8	3.17	2.3	14.0	12.2	26.4	52.8
UTT-4	1/4	6.35	4.6	17.5	14.9	29.0	58.0
UTT-6	3/8	9.52	7.1	20.0	17.8	34.8	69.6
UTT-8	1/2	12.70	10.2	23.5	20.5	34.8	69.6
UTT-12	3/4	19.05	15.7	31.5	25.3	43.3	86.9
UTT-16	1	25.40	22.1	39.5	27.6	47.8	95.5

## Reducing Union

## UTUR

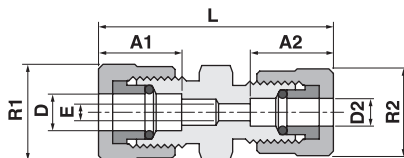

Part No.	Tube O.D				Dimensions mm					
	D <sub>1</sub>		D <sub>2</sub>		E	R <sub>1</sub>	R <sub>2</sub>	A <sub>1</sub>	A <sub>2</sub>	L
	in.	mm	in.	mm						
UTUR-6-4	3/8	9.52	1/4	6.35	4.6	20.0	17.5	17.8	14.9	45.5
UTUR-8-4	1/2	12.70	1/4	6.35	4.6	23.5	17.5	20.5	14.9	48.1

## Male Connector

## UTMC

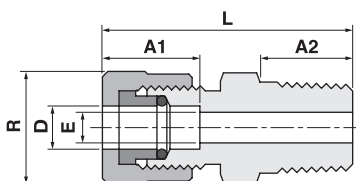

Part No.	Tube O.D		T	Dimensions mm				
	D			E	R	A <sub>1</sub>	A <sub>2</sub>	L
	in.	mm	NPT					
UTMC-1-2N	1/16	1.59	1/8	1.3	12.0	10.7	10.0	30.4
UTMC-2-2N	1/8	3.17	1/8	2.3	14.0	12.2	10.0	32.6
UTMC-4-2N	1/4	6.35	1/8	4.6	17.5	14.9	10.0	35.6
UTMC-4-4N	1/4	6.35	1/4	4.6	17.5	14.9	14.0	39.1
UTMC-6-2N	3/8	9.52	1/8	4.6	20.0	17.8	10.0	36.8
UTMC-6-4N	3/8	9.52	1/4	7.1	20.0	17.8	14.0	41.4
UTMC-8-6N	1/2	12.70	3/8	10.2	23.5	20.5	15.0	42.2
UTMC-8-8N	1/2	12.70	1/2	10.2	23.5	20.5	19.0	47.0
UTMC-12-12N	3/4	19.05	3/4	15.7	31.5	25.3	19.0	51.3
UTMC-16-16N	1	25.4	1	22.1	39.5	27.6	24.0	57.2

S-Lok Tube Adapter

**UTA**

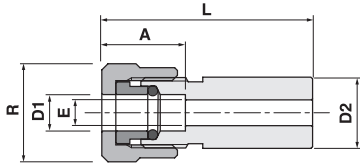

Part No.	Tube O.D				Dimensions mm			
	D <sub>1</sub>		D <sub>2</sub>		E	R	A	L
	in.	mm	in.	mm				
UTA-1-4	1/16	1.59	1/4	6.35	1.3	12.0	10.7	29.0
UTA-2-4	1/8	3.17	1/4	6.35	2.3	14.0	12.2	31.5
UTA-2-6	1/8	3.17	3/8	9.52	2.3	14.0	12.2	31.8
UTA-4-4	1/4	6.35	1/4	6.35	4.6	17.5	14.9	34.0
UTA-4-6	1/4	6.35	3/8	9.52	4.6	17.5	14.9	34.0
UTA-4-8	1/4	6.35	1/2	12.7	4.6	17.5	14.9	37.6
UTA-6-6	3/8	9.52	3/8	9.52	7.1	20.0	17.8	37.6
UTA-6-8	3/8	9.52	1/2	12.7	7.1	20.0	17.8	40.4
UTA-8-10	1/2	12.7	5/8	15.87	10.2	23.5	20.5	41.7
UTA-8-12	1/2	12.7	3/4	19.05	10.2	23.5	20.5	43.2
UTA-12-16	3/4	19.05	1	25.4	15.7	31.5	25.3	45.7
UTA-16-20	1	25.4	1 1/4	31.57	22.1	39.5	27.6	45.8
UTA-24-24	1 1/2	38.1	1 1/2	38.1	35.1	52.0	27.6	51.8

S-Lok Tube Fitting Connector

**UTUS**

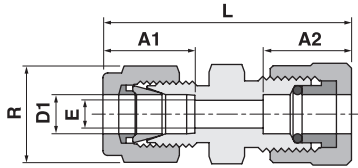

Part No.	Tube O.D		Dimensions mm				
	D		E	R	A <sub>1</sub>	A <sub>2</sub>	L
	in.	mm					
UTUS-4	1/4	6.35	4.6	17.5	14.9	15.2	42.4
UTUS-6	3/8	9.52	7.1	20.0	17.8	16.9	46.2
UTUS-8	1/2	12.7	10.2	23.5	20.5	22.9	49.8

Nut

**UTN**

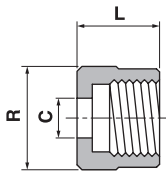

Part No.	Tube O.D		Thread Size	Dimensions mm (in.)		
	D			C	R	L
	in.	mm				
UTN-1	1/16	1.59	1/4-20 UNC	1.7	12.0	10.6
UTN-2	1/8	3.17	3/8-20 UN	3.3	14.0	10.6
UTN-4	1/4	6.35	1/2-20 UNF	6.5	17.5	13.5
UTN-6	3/8	9.52	5/8-20 UN	9.6	20.0	15.5
UTN-8	1/2	12.70	3/4-20 UNEF	12.8	23.5	15.7
UTN-10	5/8	15.87	15/16-20 UNEF	16.0	27.5	15.7
UTN-12	3/4	19.05	11/16-20 UN	19.2	31.5	18.3
UTN-16	1	25.40	13/8-20 UN	25.5	39.5	18.3
UTN-24	1 1/2	38.10	17/8-20 UN	38.2	52.0	18.3