

HITRAK-HYDRAULIIKKALIITTIMET

BSP-HYDRAULIIKKALIITTIMET

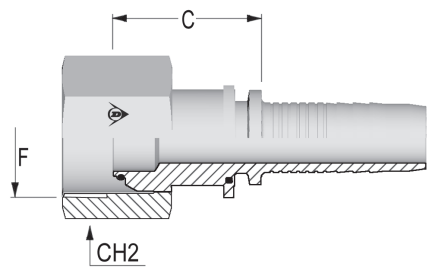

SISÄKIERRE BSP 60° A50001-XX-XX

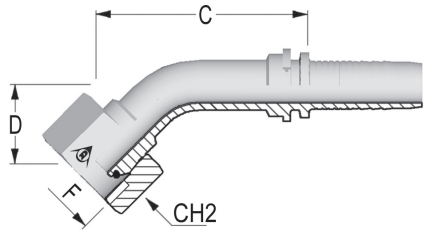

45° SISÄKIERRE BSP 60° A50061-XX-XX

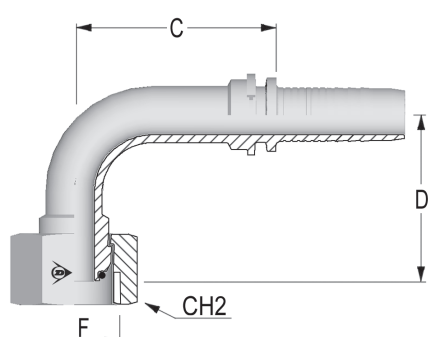

90° SISÄKIERRE BSP 60° A50051-XX-XX

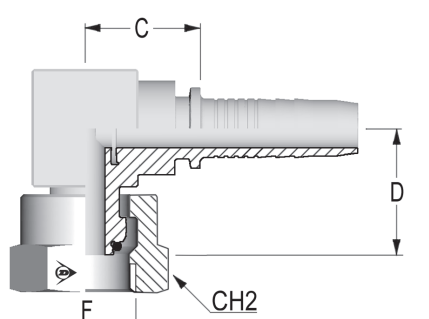

90° SISÄKIERRE BSP 60° A50180-XX-XX

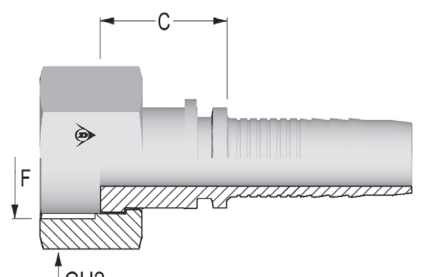

SISÄKIERRE BSP (HIAB) A50003-XX-XX

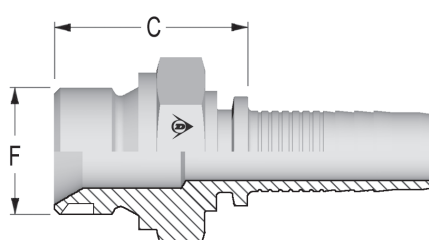

ULKOKIERRE BSP 60° 500120-XX-XX

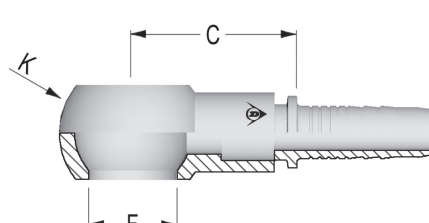

BSP BANJOLIITIN RNR 502190-XX-XX

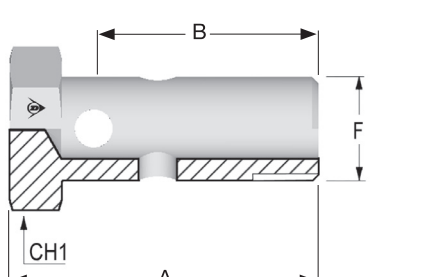

BSP BANJOPULTTI 570RPL-XX-XX

JIC 37° -HYDRAULIIKKALIITTIMET

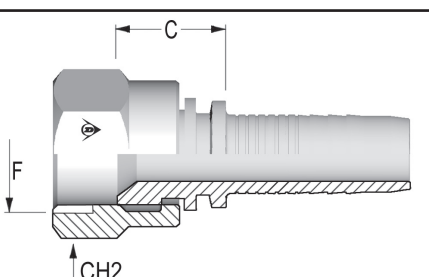

SISÄKIERRE JIC 37° A50005-XX-XX

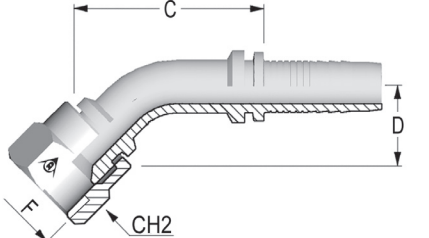

45° SISÄKIERRE JIC 37° A50064-XX-XX

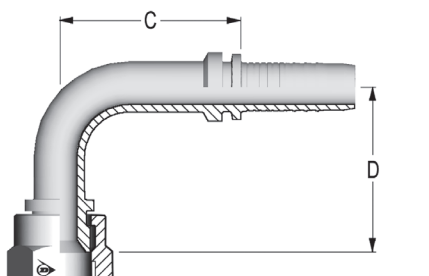

90° SISÄKIERRE JIC 37° A50054-XX-XX

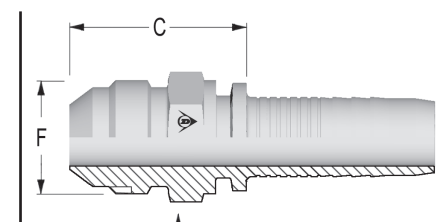

ULKOKIERRE JIC 37° 500200-XX-XX

JIS-HYDRAULIIKKALIITTIMET

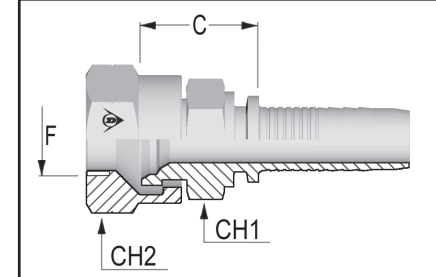

SISÄKIERRE JIS 60° (MITSUBISHI) A50A02-XX-XX

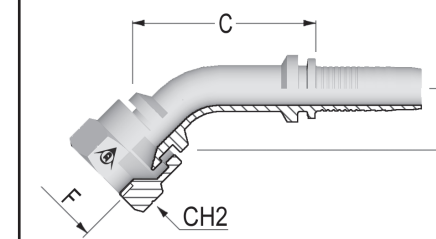

45° SISÄKIERRE JIS 60° (MITSUBISHI) A50A07-XX-XX

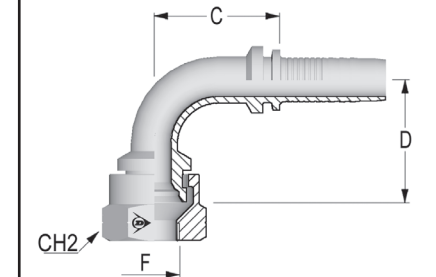

90° SISÄKIERRE JIS 60° (MITSUBISHI) A50A06-XX-XX

ORFS-HYDRAULIIKKALIITTIMET

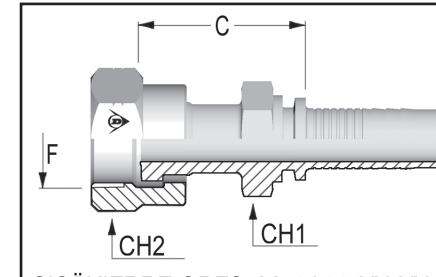

SISÄKIERRE ORFS M50A26-XX-XX

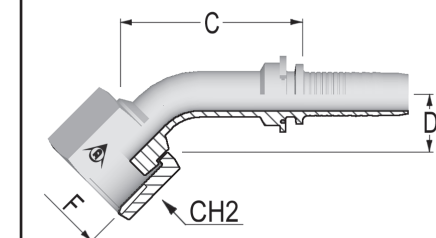

45° SISÄKIERRE ORFS M50A27-XX-XX

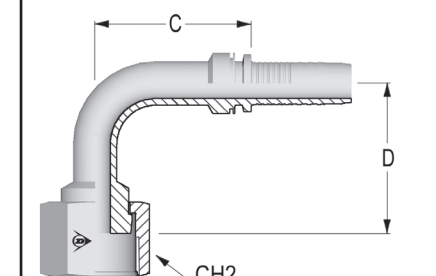

90° SISÄKIERRE ORFS M50A28-XX-XX

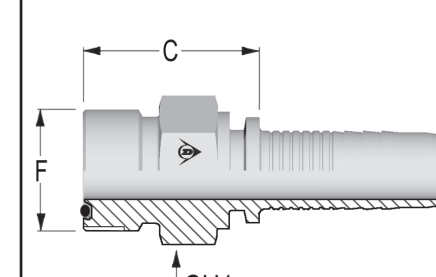

ULKOKIERRE ORFS 50A290-XX-XX

DIN-HYDRAULIIKKALIITTIMET

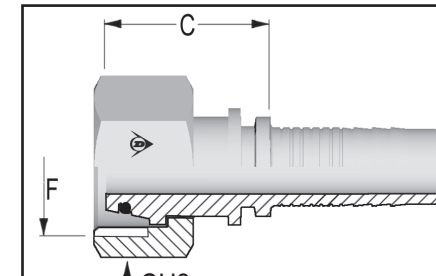

SISÄKIERRE DKOL - DIN 3865 A50146-XX-XX

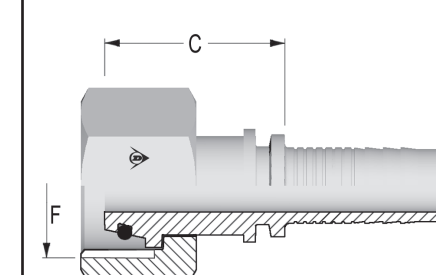

SISÄKIERRE DKOS - DIN 3865 A50179-XX-XX

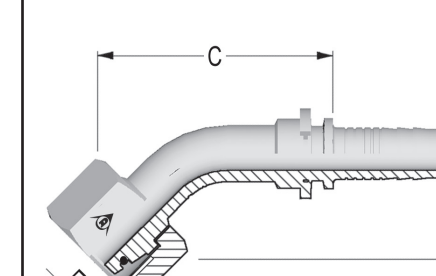

45° SISÄKIERRE DKOL - DIN 3865 A50A51-XX-XX

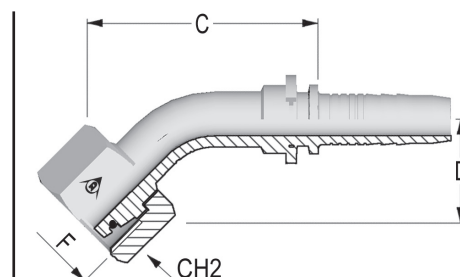

45° SISÄKIERRE DKOS - DIN 3865 A50A56-XX-XX

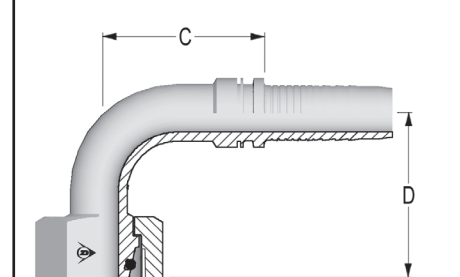

90° SISÄKIERRE DKOL - DIN 3865 A50A50-XX-XX

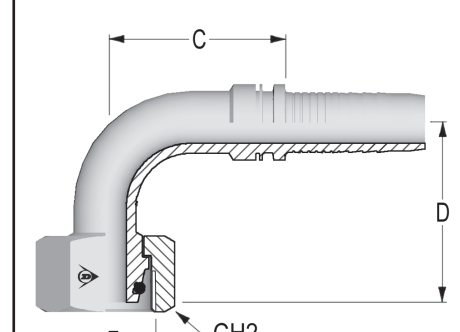

90° SISÄKIERRE DKOS - DIN 3865 A50A57-XX-XX

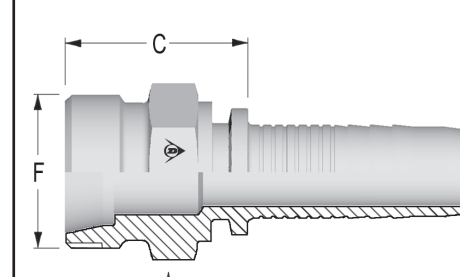

PUTKITARTUNNAT KEVYT SARJA CEL - DIN 3853 501690-XX-XX

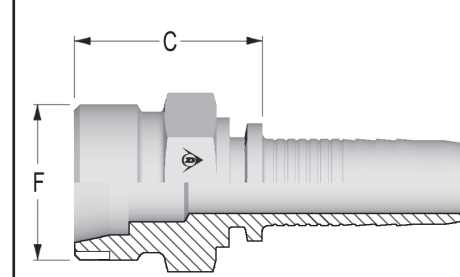

PUTKITARTUNNAT RASKAS SARJA CES - DIN 3853 501700-XX-XX

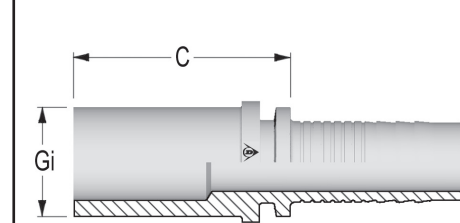

PUTKIJATKEET RSL/RSS - DIN 2353 500930-XX-XX / 500940-XX-XX

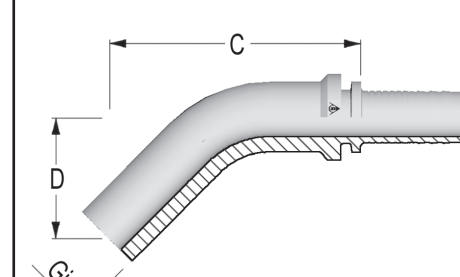

45° PUTKIJATKEET KEVYT RSL/RSS - DIN 2353 509490-XX-XX / 509500-XX-XX

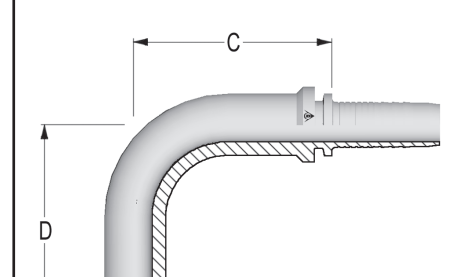

90° PUTKIJATKEET RSL/RSS - DIN 2353 509390-XX-XX / 509400-XX-XX

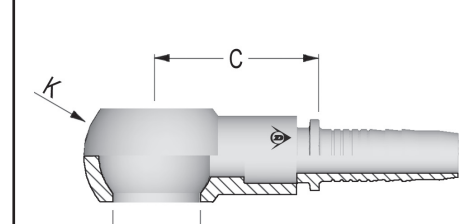

BANJOLIITIN M 500RLO-XX-XX

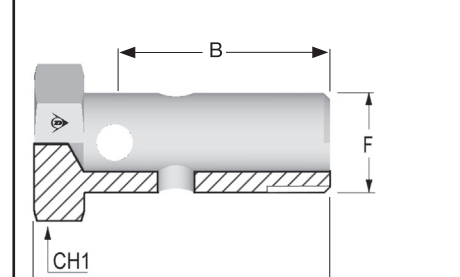

BANJOPULTTI M 570RPL-MXX

SAE-LAIPPALIITTIMET

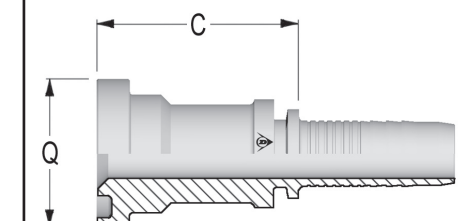

LAIPPALIITIN SAE 3000 PSI 500250-XX-XX

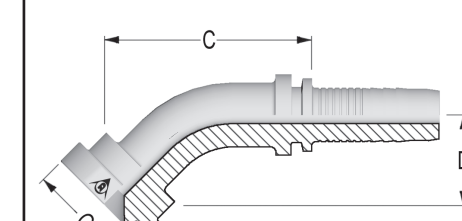

45° LAIPPALIITIN SAE 3000 PSI 500680-XX-XX

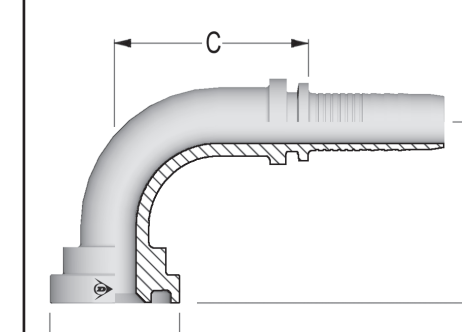

90° LAIPPALIITIN SAE 3000 PSI 500580-XX-XX

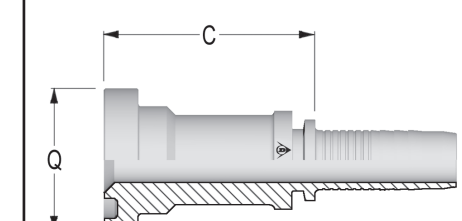

LAIPPALIITIN SAE 6000 PSI 501590-XX-XX

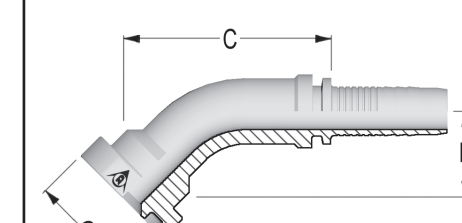

45° LAIPPALIITIN SAE 6000 PSI 501610-XX-XX

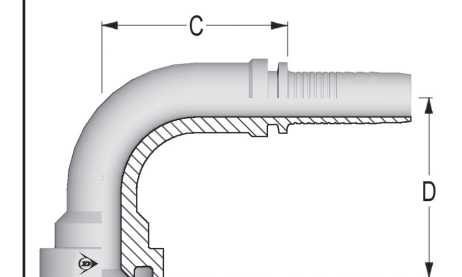

90° LAIPPALIITIN SAE 6000 PSI 501600-XX-XX

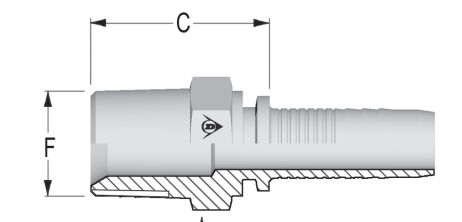

KARTIOULKOKIERRE NPTF 60° AGN 500170-XX-XX

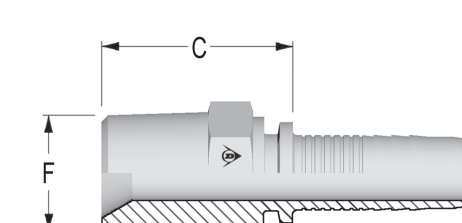

KARTIOULKOKIERRE RK (BSPT)-KIERRE 500150-XX-XX

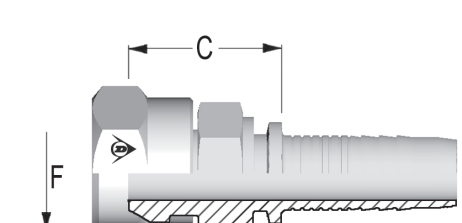

NPSM SISÄKIERRE A50090-XX-XX

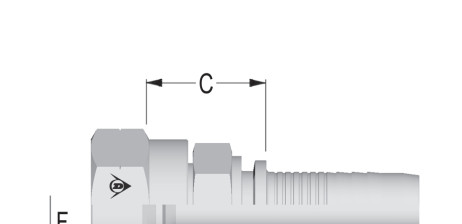

SISÄKIERRE KOMATSU 60° A50A03-XX-XX



JATKOLIITIN H12C5610-XX-XX